

## MODULAR ALUMINUM BUILDABLE BOX

**TABULATED DATA**  
**Effective July 24, 2018**  
**YELLOW**

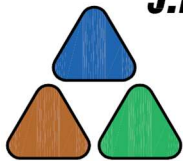
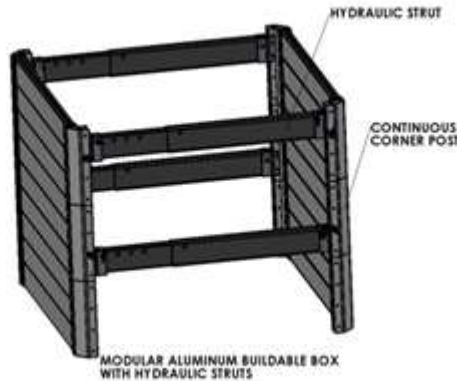
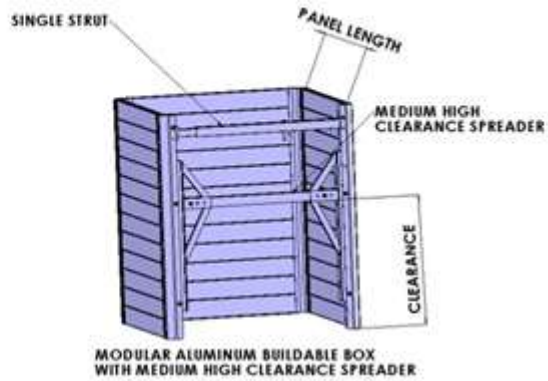
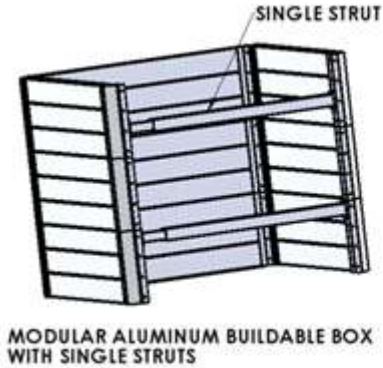

---

**Contents**

Description.....	2
General Information for use of Pacific Shoring Modular Aluminum Buildable Box .....	3
Classification of Soil Types.....	3
Determining Buildable Box Shoring Configurations .....	5
Buildable Box Components.....	6
Determining Buildable Box Weight .....	7
Geometric Properties for Engineering Design.....	8
Allowable Buildable Box Wall Panel Spans .....	9
Allowable Corner Post Spans .....	10
Allowable Strut Spans.....	12
Splice Kit .....	13
Buildable Box High Clearance Spreader Applications.....	14
Buildable Box Installation and Removal .....	15
Safe Handling and Use of Buildable Box Shoring System .....	15

**Description**

The Pacific Shoring Modular Buildable Box is an aluminum shoring system consisting of 2.8” x 8” tongue and groove panels, corner posts, and a strut system at the ends. The system can be constructed in 2 sided, 3 sided, and 4 sided configurations. The posts, panels and struts are pinned in place. This allows construction and modification of the box at the site. The panel lengths vary from 3 ft to 16 ft long. Corner posts vary in length from 2 ft to 8 ft. Boxes may be stacked and allow depths to 25 ft. Hand adjustable struts, static struts, and hydraulic struts adjusting to maximum 12 ft may be used with the system. A 4 sided configuration may be used up to 16 ft x16 ft. These boxes may be used in a static or dynamic configuration. A static configuration assumes that the box wall does not necessarily touch the sides of the excavation and that there is no pressure being exerted on the soil. A dynamic configuration requires that the shield walls are pressurized against the soil. Pressurization sets up soil arching, delivers some of the soil pressure directly to the corners, and therefore results in less pressure on the box walls. With this configuration, slightly longer wall lengths can be achieved and the possibility of shoring wall collapse and surrounding existing facility damage can be prevented.

This shoring system is generally used in utility work where differing conditions and excavation geometry occur on a daily basis. The system can be easily loaded onto a truck and constructed at the site as the excavation dimensions and obstructions reveal themselves. Parts may be handled by one person and constructed boxes can be handled with a backhoe.

---

## **General Information for use of Pacific Shoring Modular Aluminum Buildable Box**

1. The buildable box shoring system tabulated here is based on requirements of Federal OSHA 29CFR, Part 1926, Subpart P-Excavations and Trenches

**1926.652(c)(2)**-Option (2) - Designs Using Manufacturer's Tabulated Data.

1926.652(c)(2)(i) -Design of support systems, shield systems, or other protective systems that are drawn from manufacturer's tabulated data shall be in accordance with all specifications, recommendations, and limitations issued or made by the manufacturer.

All provisions of Subpart P apply when utilizing this tabulated data. The contractor's competent person shall use this data to select allowable trench depth, box wall, and strut configuration. The competent person utilizing this tabulated data shall be experienced and knowledgeable of all requirements of Subpart P, and trained in the use and safety procedures for shoring box applications.

2. Use of this tabulated data is dependent on first classifying the soil in accordance with OSHA Appendix A, Soil Classification. Classification shall be just prior to installing shoring box. Soil conditions may change at a later date and require reevaluation of the strength and allowable depth.
3. Modular Aluminum Buildable Boxes are tabulated based on the effect of a 20,000 lb surcharge load set back 2 ft from the edge of the trench and the equivalent weight effect of the OSHA soil type, see classification of soil types, 2.
4. The depth and spacing given in **Tables 1, 2, and 3** governs the use of Pacific Shoring Buildable Boxes and not tabulations given by other manufacturers. This tabulated data applies exclusively to Buildable Boxes manufactured by Pacific Shoring LLC. Any alterations to the boxes or variance from this tabulated data shall be indicated in a site-specific plan prepared and approved by a registered engineer.
5. Faces of excavations shall be vertical and the shoring walls shall be within 12" of the excavation wall.
6. Aluminum Buildable Boxes may be stacked or longitudinally connected
7. Aluminum Buildable Boxes shall be installed and removed from outside the trench, see installation and removal procedure.
8. The competent person shall continually monitor the shored excavation for changed conditions such as water seepage, soil movement cracks at the surface, sloughing or raveling, proper surcharge load weight less than 20,000 lbs and setback a minimum of 2 ft that may damage the shores.
9. Workers shall always enter, exit, and work inside the shored area of the trench.
10. Aluminum Buildable Boxes may be stacked as long as they are pinned together.
11. Aluminum Buildable Boxes may set a maximum of 2 ft from the bottom of the excavation. The trench depth is the full distance to the bottom of the excavation.

## Classification of Soil Types

1. Soil classification shall be in accordance with OSHA Appendix A and classified just prior to installing hydraulic vertical shores. Soil conditions may change at a later date and require buildable boxes to be reconfigured at different spacing.
2. The equivalent weight of OSHA soil types\* is assumed to be as follows:
  - OSHA Type “A” Soil                      25 PSF per ft of depth
  - OSHA Type “B” Soil                      45 PSF per ft of depth
  - Type “C-60” Soil                         60 PSF per ft of depth\*\*
  - OSHA Type “C” Soil                      80 PSF per ft of depth
- \* These equivalent weights were adapted from OSHA 1926 Subpart P App C, Timber Shoring for Trenches, Tables C-1.1, C-1.2, and C-1.3
- \*\* Type C-60 soil is not identified or classified in OSHA Appendix A
3. Type C-60 soil is soil that does not qualify as OSHA Type A, or Type B, can be cut with vertical walls and will stand up long enough to safely insert and pressurize the hydraulic shore.
4. Buildable boxes may be used in C-80 soil provided they are dug into the excavation and not driven into the soil.

## Determining Buildable Box Shoring Configurations

Shoring use and configurations shall be determined by the user (employer and designated competent person). The following steps are necessary to properly configure and construct a buildable box shoring system:

1. Define soil type in accordance with OSHA Appendix A
2. Determine surcharge loading. All shoring equipment is designed for a maximum of a 20,000 lb surcharge load set back 2 ft from the edge of the trench. Larger loads shall be set back further or reduced. The competent person shall have training and knowledge in proper determination of surcharge loads.
3. Determine length, width, and depth of shoring requirement.
4. Determine existing facilities and depths that they will enter into the shoring configuration.
5. Determine depths, locations, and clearance requirements of facilities that will be constructed inside the shoring.
6. Determine components of the Buildable Box system needed to fit the requirements of the system. These components will at a minimum consist of:
  - Wall panels
  - Corner posts
  - Strutting for 2 and 3 sided boxes
  - High clearance strutting for constructed facilities entering or exiting the shoring system
7. Determine allowable depths and settings for components as follows:
  - a) Wall Panels - **Table 1 - Allowable Depth for Buildable Box wall Panels**
  - b) Corner posts - **Table 2 - Allowable Corner Post Spans.**  
Corner posts have an allowable cantilever span and allowable strut spacing span based on the depth of the excavation. These tables apply to hydraulic spreaders, pinned end struts, and screw jack struts.
  - c) Struts - **Table 3 - Allowable Strut Lengths**
  - d) High clearance strutting - **Table 4 - Allowable Depth using High Clearance Spreader**
8. Determine approximate shoring system weight before rigging. Rigging equipment and connections should have a 5:1 factor of safety.

**Note** - The medium high clearance spreader allows more depth than the high clearance spreader

## Buildable Box Components

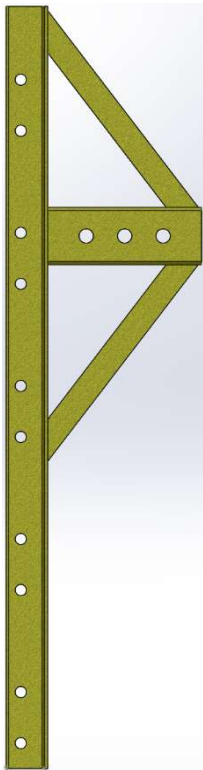
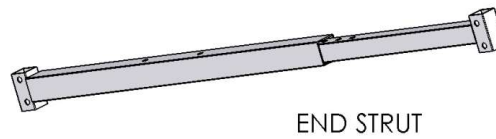
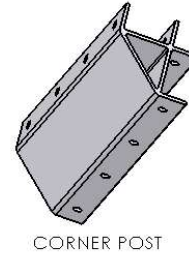
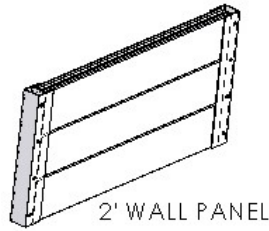

High Clearance Arch - A

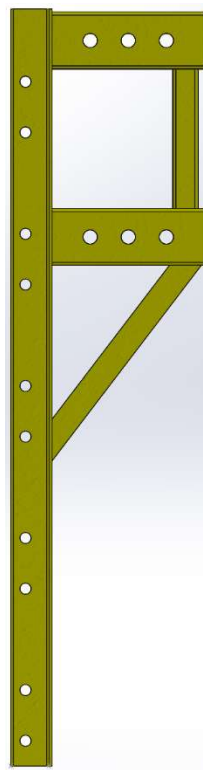

High Clearance Arch - B

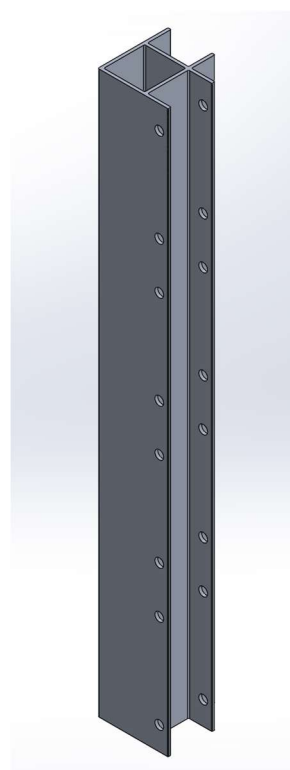

Square Corner Post

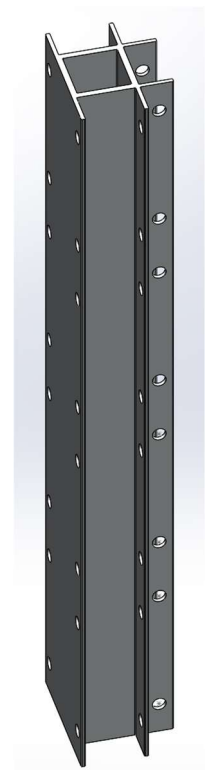

Middle T-Post



Buildable Box components are manufactured in several different sizes that can be pinned together in practically any size box. Sizes available are as follows:

2' wall panel            4 ft    6 ft    8 ft    10 ft    12 ft    16 ft    Custom Length  
 Corner Post            2 ft    4 ft    8ft    Custom Length  
 End Strut                4 ft to 6 ft    6 ft to 8 ft    8 ft to 12 ft    12 ft to 16 ft    Custom Length

**Determining Buildable Box Weight**

To determine the weight of the constructed box use the weights given in tables.

Example - Determine the weight of a Buildable Box 8 ft deep x 12 ft long x 6 ft wide

Total Weight of 3 Sided Box			
length	12 ft		
width	6 ft		
sides	3 ea	12' long x 6' wide	
struts	2 ea	End Strut	
qty	Description	Unit Weight	qty Weight
8	2'x12' Wall Panels	126 lbs ea	1008 lbs
4	2' x 6' wall panels	97 lbs ea	388 lbs
32	1f corner post	6.32 lbs / 1f	202 lbs
48	pins	1 lbs ea	48 lbs
12	1f end strut	17 lbs/1f	204 lbs
<b>Total Weight</b>			<b>1850 lbs</b>

Panel Weights		
Depth (ft)	Length (ft)	Weight (lbs)
2	3	53
2	4	68
2	5	82
2	6	97
2	7	111
2	8	126
2	10	155
2	12	184
2	13	199
2	14	213
2	16	242

Miscellaneous Parts Weight	
Corner posts	6.32 lbs/1f
Pins*	1 lbs ea
Screw Jack	10 lbs/1f
End strut	17 lbs/1f
*Allow 4 pins per 2 ft panel	

## Geometric Properties for Engineering Design

### MATERIALS

Extruded Aluminum 6061-T6  
 Ultimate Tensile Strength  $F_{tu} = 45,000$  psi  
 Tensile Yield Strength  $F_{ty} = 40,000$  psi  
 Modulus of Elasticity = 10,000 ksi

Extruded Aluminum 6005A-T61  
 Ultimate Tensile Strength  $F_{tu} = 45,000$  psi  
 Tensile Yield Strength  $F_{ty} = 40,000$  psi  
 Modulus of Elasticity = 10,000 ksi

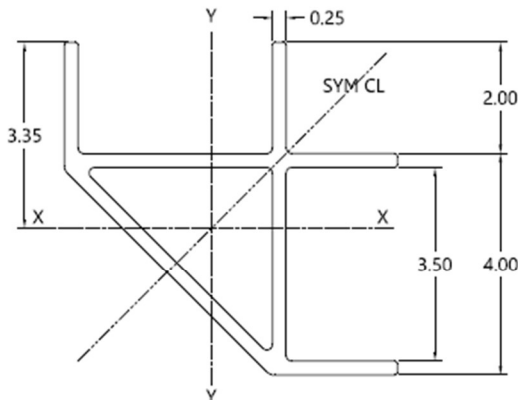

**CORNER POST**  
 AREA = 5.11 IN<sup>2</sup>  
 WEIGHT = 6.32 LBS/FT  
 MOMENT OF INERTIA = 8.58 IN<sup>4</sup>  
 SECTION MODULUS = 2.56 IN<sup>3</sup>

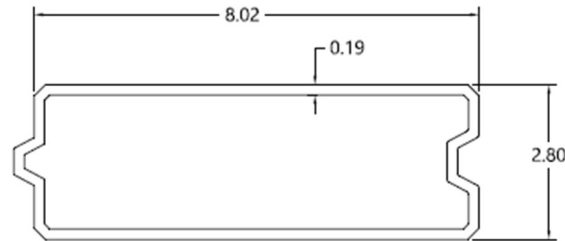

**BUILDABLE BOX PANEL**  
 AREA = 4.03 IN<sup>2</sup>  
 WEIGHT = 4.84 LBS/FT  
 MOMENT OF INERTIA = 5.50 IN<sup>4</sup>  
 SECTION MODULUS = 3.93 IN<sup>3</sup>

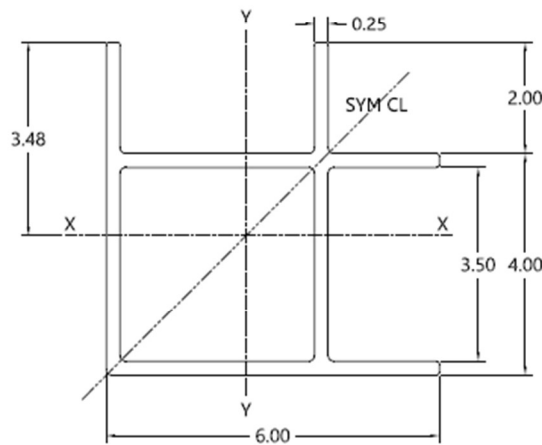

**SQUARE CORNER POST**  
 AREA = 5.77 IN<sup>2</sup>  
 WEIGHT = 6.93 LBS/FT  
 MOMENT OF INERTIA = 20.16 IN<sup>4</sup>  
 SECTION MODULUS = 5.79 IN<sup>3</sup>

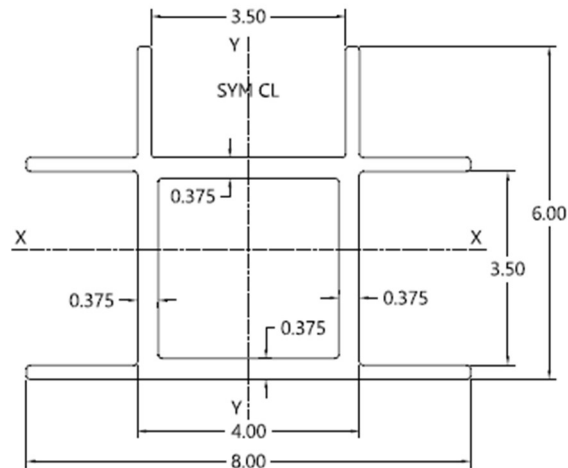

**MIDDLE T-POST**  
 AREA = 8.44 IN<sup>2</sup>  
 WEIGHT = 10.14 LBS/FT  
 MOMENT OF INERTIA = 27.29 IN<sup>4</sup>  
 SECTION MODULUS = 7.49 IN<sup>3</sup>



## Allowable Buildable Box Wall Panel Spans

To determine the allowable depth for a Buildable Box panel length use **Table 1** below.

Example - If the longest wall panel element is 12 ft long and to be used in C-60 soil, from **Table 1** the box may be used to a depth of 11 ft.

Panel Length (ft)	Panel Capacity (PSF)	Allowable Depth (ft)			
		OSHA Soil Type			
		A-25	B-45	C-60	C-80
3	12227	25	25	25	25
4	6878	25	25	25	25
5	4402	25	25	25	25
6	3057	25	25	25	25
7	2246	25	25	25	25
8	1840	25	25	25	23
10	1176	25	25	20	15
12	816	25	18	14	10
13	696	25	15	12	9
14	600	24	13	10	8
16	456	18	10	8	6

### Table 1 Notes

1. Wall panels are Pacific Shoring Buildable Box Panels as detailed in this tabulated data.
2. The longest box wall in the constructed box shall govern the allowable depth given in **Table 1**
3. Two and three sided boxes shall be strutted. See **Table 2** for allowable corner post spans and **Table 3** for allowable strut lengths.
4. If the box is used with hydraulic struts and is pressurized against the trench wall, the allowable depth may be increased by 2 ft but may never be set more than 25 ft deep.

### Allowable Corner Post Spans

On two and three sided boxes, use **Table 2** to determine the allowable corner post cantilever and strut spacing.

Example - If the longest wall panel element on a 3 sided box is 12 ft long and to be used in C-60 soil at 11 ft deep, from **Table 2-12**, the maximum corner post cantilever can be 2 ft and the maximum strut spacing can be 4 ft.

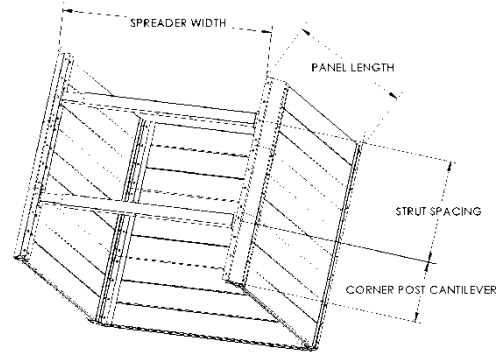

**TABLE 2-3 ALLOWABLE CORNER POST SPANS FOR**  
WALL PANEL LENGTH = 3 ft

Depth (ft)	Corner Post Cantilever(ft)				Strut Spacing (ft)			
	Soil Type				Soil Type			
	A25	B45	C60	C80	A25	B45	C60	C80
6	7	5	5	4	16	12	11	9
8	6	5	4	4	14	11	9	8
10	6	4	4	3	13	9	8	7
12	5	4	3	3	12	9	7	6
14	5	4	1	3	11	8	3	6
16	4	3	1	2	10	7	3	6
18	4	3	3	2	9	7	6	5
20	4	3	3	2	9	7	6	5

**TABLE 2-4 ALLOWABLE CORNER POST SPANS FOR**  
WALL PANEL LENGTH = 4 ft

Depth (ft)	Corner Post Cantilever(ft)				Strut Spacing (ft)			
	Soil Type				Soil Type			
	A25	B45	C60	C80	A25	B45	C60	C80
6	6	5	4	4	14	11	9	8
8	5	4	4	3	12	9	8	7
10	5	4	3	3	11	8	7	6
12	4	3	3	2	10	7	6	6
14	4	3	1	2	9	7	3	5
16	4	3	1	2	9	6	3	5
18	4	3	2	2	8	6	5	5
20	3	3	2	2	8	6	5	4

**TABLE 2-5 ALLOWABLE CORNER POST SPANS FOR**  
WALL PANEL LENGTH = 5 ft

Depth (ft)	Corner Post Cantilever(ft)				Strut Spacing (ft)			
	Soil Type				Soil Type			
	A25	B45	C60	C80	A25	B45	C60	C80
6	6	4	4	3	13	9	8	7
8	5	4	3	3	11	8	7	6
10	4	3	3	2	10	7	6	5
12	4	3	3	2	9	7	6	5
14	4	3	1	2	8	6	3	5
16	3	3	1	2	8	6	3	4
18	3	2	2	2	7	5	5	4
20	3	2	2	2	7	5	4	4

**TABLE 2-6 ALLOWABLE CORNER POST SPANS FOR**  
WALL PANEL LENGTH = 6 ft

Depth (ft)	Corner Post Cantilever(ft)				Strut Spacing (ft)			
	Soil Type				Soil Type			
	A25	B45	C60	C80	A25	B45	C60	C80
6	5	4	3	3	12	9	7	6
8	4	3	3	2	10	7	6	6
10	4	3	3	2	9	7	6	5
12	4	3	2	2	8	6	5	5
14	3	3	1	2	8	6	3	4
16	3	2	1	2	7	5	3	4
18	3	2	2	2	7	5	4	4
20	3	2	2	2	6	5	4	4

**TABLE 2-7 ALLOWABLE CORNER POST SPANS FOR**  
WALL PANEL LENGTH = 7 ft

Depth (ft)	Corner Post Cantilever(ft)				Strut Spacing (ft)			
	Soil Type				Soil Type			
	A25	B45	C60	C80	A25	B45	C60	C80
6	5	4	3	3	11	8	7	6
8	4	3	3	2	9	7	6	5
10	4	3	2	2	8	6	5	5
12	3	3	2	2	8	6	5	4
14	3	2	1	2	7	5	3	4
16	3	2	1	2	7	5	3	4
18	3	2	2	2	6	5	4	3
20	3	2	2	1	6	4	4	3

**TABLE 2-8 ALLOWABLE CORNER POST SPANS FOR**  
WALL PANEL LENGTH = 8 ft

Depth (ft)	Corner Post Cantilever(ft)				Strut Spacing (ft)			
	Soil Type				Soil Type			
	A25	B45	C60	C80	A25	B45	C60	C80
6	4	3	3	2	10	7	6	6
8	4	3	2	2	9	6	6	5
10	3	3	2	2	8	6	5	4
12	3	2	2	2	7	5	5	4
14	3	2	1	2	7	5	3	4
16	3	2	1	2	6	5	3	3
18	3	2	2	1	6	4	4	3
20	2	2	2	1	5	4	4	3



TABLE 2-10 ALLOWABLE CORNER POST SPANS FOR									
WALL PANEL LENGTH = 10 ft									
Depth (ft)	Corner Post Cantilever(ft)				Strut Spacing (ft)				
	Soil Type				Soil Type				
	A25	B45	C60	C80	A25	B45	C60	C80	
6	4	3	3	2	9	7	6	5	
8	3	3	2	2	8	6	5	4	
10	3	2	2	2	7	5	4	4	
12	3	2	2	2	6	5	4	4	
14	3	2	1	1	6	4	3	3	
16	2	2	1	1	5	4	3	3	
18	2	2	1	1	5	4	3	3	
20	2	2	1	1	5	4	3	3	

TABLE 2-12 ALLOWABLE CORNER POST SPANS FOR									
WALL PANEL LENGTH = 12 ft									
Depth (ft)	Corner Post Cantilever(ft)				Strut Spacing (ft)				
	Soil Type				Soil Type				
	A25	B45	C60	C80	A25	B45	C60	C80	
6	4	3	2	2	8	6	5	5	
8	3	2	2	2	7	5	5	4	
10	3	2	2	2	6	5	4	4	
12	3	2	2	1	6	4	4	3	
14	2	2	1	1	5	4	3	3	
16	2	2	1	1	5	4	3	3	
18	2	2	1	1	5	4	3	3	
20	2	1	1	1	4	3	3	2	

TABLE 2-13 ALLOWABLE CORNER POST SPANS FOR									
WALL PANEL LENGTH = 13 ft									
Depth (ft)	Corner Post Cantilever(ft)				Strut Spacing (ft)				
	Soil Type				Soil Type				
	A25	B45	C60	C80	A25	B45	C60	C80	
6	4	3	2	2	8	6	5	4	
8	3	2	2	2	7	5	4	4	
10	3	2	2	2	6	5	4	3	
12	2	2	2	1	6	4	4	3	
14	2	2	1	1	5	4	3	3	
16	2	2	1	1	5	4	3	3	
18	2	2	1	1	5	3	3	3	
20	2	1	1	1	4	3	3	2	

TABLE 2-14 ALLOWABLE CORNER POST SPANS FOR									
WALL PANEL LENGTH = 14 ft									
Depth (ft)	Corner Post Cantilever(ft)				Strut Spacing (ft)				
	Soil Type				Soil Type				
	A25	B45	C60	C80	A25	B45	C60	C80	
6	3	3	2	2	8	6	5	4	
8	3	2	2	2	7	5	4	4	
10	3	2	2	1	6	4	4	3	
12	2	2	2	1	5	4	3	3	
14	2	2	1	1	5	4	3	3	
16	2	2	1	1	5	3	3	3	
18	2	1	1	1	4	3	3	2	
20	2	1	1	1	4	3	3	2	

TABLE 2-16 ALLOWABLE CORNER POST SPANS FOR									
WALL PANEL LENGTH = 16 ft									
Depth (ft)	Corner Post Cantilever(ft)				Strut Spacing (ft)				
	Soil Type				Soil Type				
	A25	B45	C60	C80	A25	B45	C60	C80	
6	3	2	2	2	7	5	5	4	
8	3	2	2	2	6	5	4	3	
10	2	2	2	1	5	4	4	3	
12	2	2	1	1	5	4	3	3	
14	2	2	1	1	5	3	3	3	
16	2	1	1	1	4	3	3	2	
18	2	1	1	1	4	3	3	2	
20	2	1	1	1	4	3	2	2	

**Table 2 Notes**

1. Always use a minimum of two struts per corner post.
2. Short sectional corner posts shall have a strut top and bottom.
3. Long corner posts shall have strutting spaced as shown in these tables.
4. Interpolation between tables is OK

## Allowable Strut Spans

**Table 3** gives the maximum strut length allowed for any Buildable Box configuration. Longer lengths may be allowed as determined by a registered engineer.

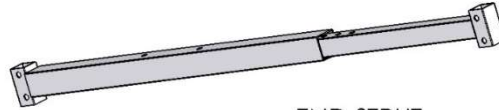

END STRUT

TABLE 3-1 ALLOWABLE END STRUT LENGTH				
Depth	Soil Type			
(FT)	A25	B45	C60	C80
10	16	14	12	10
16	14	12	10	8
20	12	10	8	6

## Splice Kit

TABLE 4-ALLOWABLE DEPTH FOR BUILDABLE BOX SPLICED WALL PANELS					
Spliced Panel Length (ft)	Panel Capacity (PSF)	Maximum Depth for Soil Type (ft)			
		OSHA Soil Type			
		A25	B45	C60	C80
3	13691	25	25	25	25
4	7303	25	25	25	25
5	4530	25	25	25	25
6	3082	25	25	25	25
7	2232	25	25	25	25
8	1690	25	25	25	20
10	1066	25	22	17	12
12	733	25	15	11	8
13	622	22	12	9	7
14	534	18	10	8	6
16	407	13	7	6	4

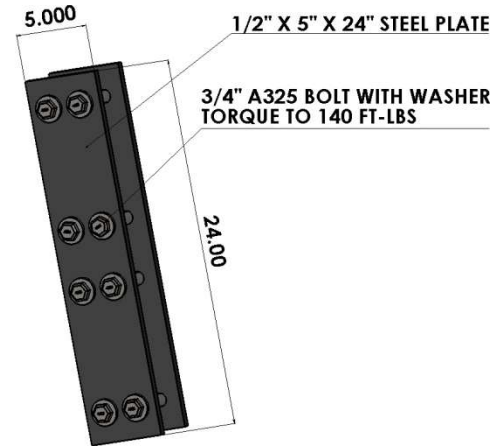

**SPLICE PLATE ASSEMBLY**

Notes;

1. Spliced panels can be any length to make up the spliced panel length.
2. Bolts must be minimum 3/4" ASTM A25 with washers both sides. Bolts must be torque to 140 foot-pounds
3. The spliced panel length rating strength is equivalent to the strength of a continuous panel of the same length.
4. Bolt heads may be on the inside or outside of the panel.

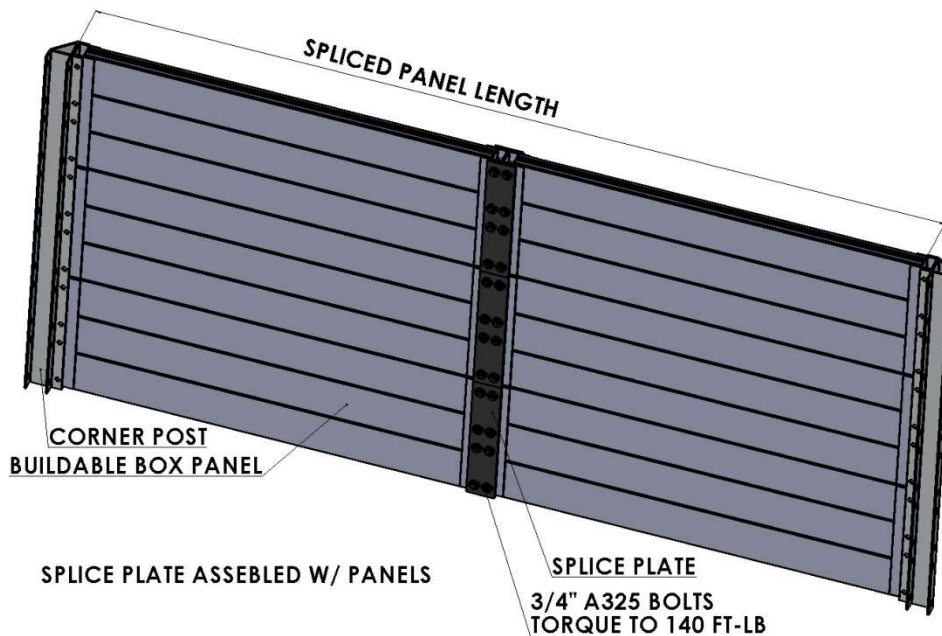

## Buildable Box High Clearance Spreader Applications

The medium clearance strut is used to achieve additional clearance below the strut. This strut can be used with buildable boxes constructed 6 ft and 8 ft high. Additional boxes may be stacked above the medium clearance strutted box.

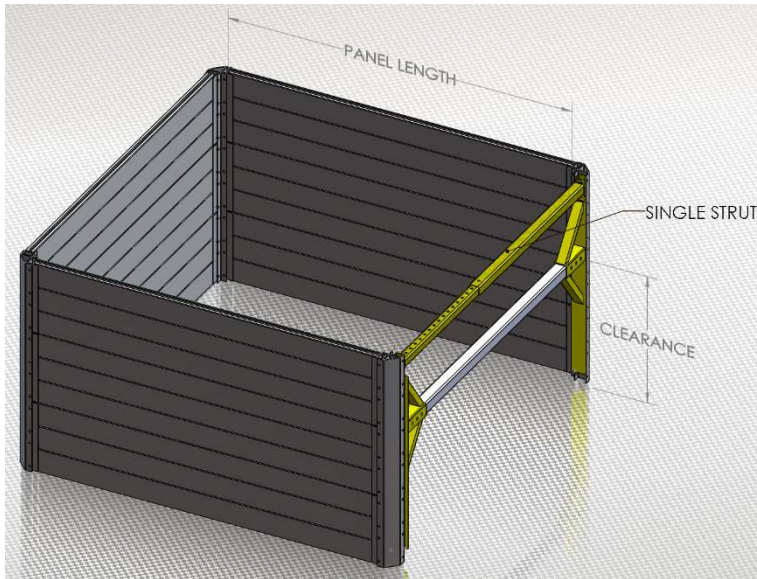

High Clearance Arch - A

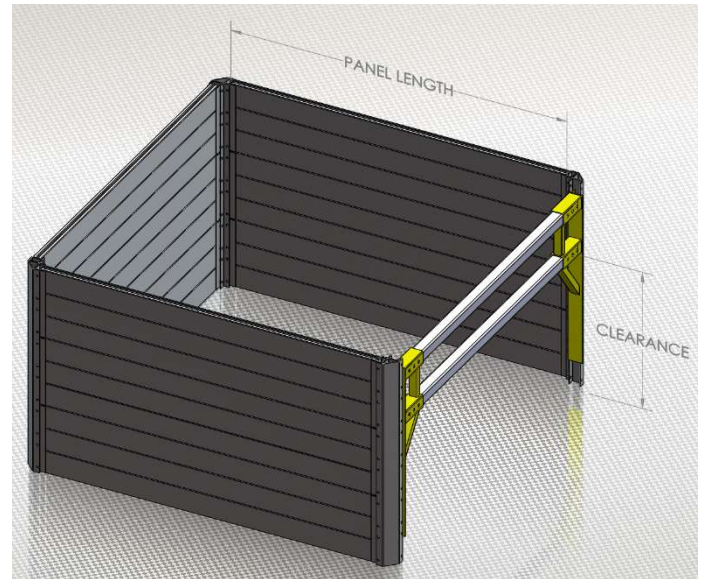

High Clearance Arch - B

TABLE 4-1 ALLOWABLE DEPTH WHEN USING MEDIUM HIGH CLEARANCE SPREADER (ft)								
Panel Length (ft)	Clearance = 4 ft				Clearance = 6 ft			
	Soil Type				Soil Type			
	A25	B45	C60	C80	A25	B45	C60	C80
3	20	20	20	16	20	20	20	16
4	20	20	20	16	20	20	20	16
5	20	20	20	16	20	20	18	16
6	20	20	20	16	20	20	16	14
8	20	20	20	16	20	18	14	10
10	20	20	18	14	14	14	10	8
12	20	18	14	8	8	8	8	6
14	20	12	8	6	6	6	6	6
16	16	8	6	0	0	0	0	0

### Table 4 Notes

1. End posts must be continuous from bottom of box to top strut.
2. There must always be a single strut used on the same end post set above the medium clearance strut.



## **Buildable Box Installation and Removal**

### **Installation Procedure**

Buildable Boxes must be constructed prior to setting inside the trench.

- Step 1 Pin panels into corner posts. Build in a stable configuration starting from corners and setting panels in opposite directions.
- Step 2 Pin in and adjust spreaders into the corner posts.
- Step 3 Lower fully constructed box into trench with lifting equipment such as backhoe, boom truck or crane.

### **Removal Procedure**

- Step 1 Remove the box using equipment operated from outside the trench. Workers are not allowed inside the box when it is being set, moved, or removed from the trench.

## **Safe Handling and Use of Buildable Box Shoring System**

- When Buildable Boxes are set in trenches that are sloped above, extend the box 18” above the hinge point. Slopes shall be in accordance with OSHA Appendix B sloping and benching.
- When there is sloping beyond the top of the box depth of the excavation is limited to 20 ft without a design by a registered engineer.
- Workers are not allowed inside the box when it is being set, moved, or removed from the trench.
- Provide safe access such as ladders for workers to enter and exit the shoring system.
- Use cables and slings for lifting that have a 5:1 factor of safety. A competent person is to determine the total lift weight.